

ADDENDUM
to the
**HP Model 6811B, 6812B, 6813B User's Guide and
HP Model 6811B, 6812B, 6813B Programming Guide**
HP Dual Power Analyzer (Option 020 or 022)

HP Part No. 5964-8134
Microfiche No 5964-8135



Printed in U.S.A.
June, 1999

Contents

HP Dual Power Analyzer Description	3
Rear Panel Connections	5
Installation	5
Front Panel Programming	8
Additional Measurement Commands	10
Additional Sense Commands	12
Additional Frequency Modulation Commands	13
Additional Calibration Commands	14
Behavior Differences of Existing SCPI Commands	15
Programming Example	16
Using the Power Analyzer Input with the GUI	17
Power Analyzer Input Specifications	20
Verification and Calibration for Option 020/022	22
Verification Procedure	23
Calibration Procedure	25

This document contains proprietary information protected by copyright. All rights are reserved. No part of this document may be photocopied, reproduced, or translated into another language without the prior consent of Hewlett-Packard Company. The information contained in this document is subject to change without notice.

© Copyright 1999 Hewlett-Packard Company

HP Dual Power Analyzer Description

The HP Dual Power Analyzer (Option 020) is available on the following ac source models:

- HP 6811B AC Power Source (375VA)
- HP 6812B AC Power Source (750VA)
- HP 6813B AC Power Source (1750VA)
- HP 6813B Option 019 AC Power Source (2000VA)

Option 020 consists of an additional Power Analyzer input on the back of the ac source, an external current shunt, and a cable to connect the current shunt to the ac source. Option 020 adds the following capabilities to the above listed ac source models:

- Voltage and current measurement inputs on the rear panel, with capabilities similar to the output voltage and current measurements available in standard HP ac sources.
- The ability to use any shunt for the external current measurement, allowing current measurements over a very wide range of magnitudes.
- Precisely synchronized measurements between the rear panel Power Analyzer input and the ac source output. This is possible because the Power Analyzer input has its own dedicated measurement buffer.
- New measurement commands that may be used in evaluating uninterruptible power supplies (To measure transfer time, peak voltage, and phase locked loop performance for example).
- Frequency modulation of the ac source output.

As shown in the following figure, the HP Dual Power Analyzer also includes an HP-supplied current shunt, which must be connected to the output of the equipment under test to make accurate voltage and current measurements. The specifications and supplemental characteristics of the HP Dual Power Analyzer are documented toward the end of this document.

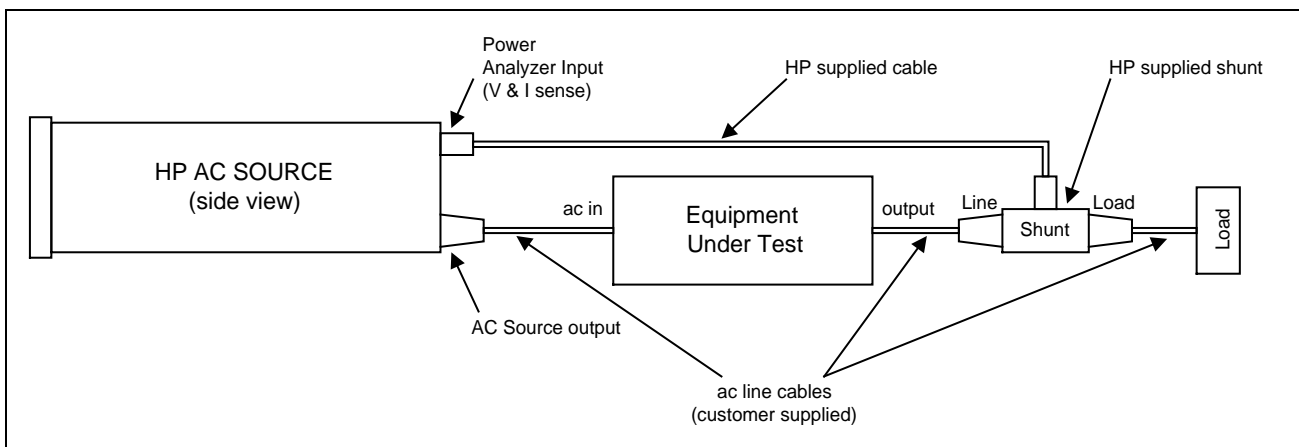

Option 020 Typical Connections

HP Option 022 Description

Option 022 is simply an HP 6813B Option 019 AC Power Source combined with an HP Dual Power Analyzer (Option 020). All of the Option 020 information in this document also applies to units that are configured as Option 022 units.

Front Panel Menus - Additions

The Power Analyzer input uses the same front panel menu commands that are used to measure the Main Output of the ac source. These are documented in the ac source User's Guide. The following menu commands have been added to let you access the Power Analyzer input, control the output frequency modulation, and calibrate the Power Analyzer input. In most cases you will need to press the Function key multiple times to access the menu item. Press the Entry key to access the parameter.

Phase Select		ϕ^1 115V 60 Hz ϕ^2 120V 60 Hz	Displays the Main Output measurement when ϕ^1 is selected Displays the Power Analyzer measurement when ϕ^2 is selected
Freq	<input type="button" value="▼"/>	FM OFF	Enable or disable output frequency modulation (OFF or ON)
	<input type="button" value="▼"/>	FM:FREQ 50	Specifies the modulating frequency of the output
	<input type="button" value="▼"/>	FM:DEV 10	Specifies the peak deviation of the output frequency modulation
Input	<input type="button" value="▼"/>	FREQ:SRC VOLT	Specifies the frequency input source (VOLT or CURR)
Shift	Cal	<input type="button" value="▼"/>	CAL:CURR: EXT Begin external current calibration
		<input type="button" value="▼"/>	CAL:VOLT: EXT Begin external voltage calibration
		<input type="button" value="▼"/>	SHUNT Enter a value for the external shunt in ohms

NOTE: With no signal connected to the Power Analyzer input, the ϕ^2 front panel display may return a very high frequency value. This is normal, since there is no external frequency for the measurement circuit to detect.

SCPI Programming Commands - Additions

The Power Analyzer input uses the same measurement commands that are used to measure the Main Output of the ac source. These are documented in the ac source User's Guide. The following SCPI commands have been added to let you access the Power Analyzer input, control the output frequency modulation, and calibrate the Power Analyzer input. Additional measurement functions let you measure transfer time, peak voltage, and phase locked loop performance when evaluating devices such as uninterruptible power supplies.

CALibrate

:CURRent
:EXTernal
:VOLTage
:EXTernal
:SHUNT

MEASure | FETCh

:VOLTage
:RANKed? <percentile>
:TVOLT? <level><occurrence>
:ABSolute? <level><start_time><min_pulse_width>

FM

:STATe <bool>
:DEViation <value>
:FREQuency <value>

SENSe

:NSElect 1 | 2
:FREQuency:SOURce VOLT | CURR

Rear Panel Connections

Power Analyzer input.
Connector plug is
removable.

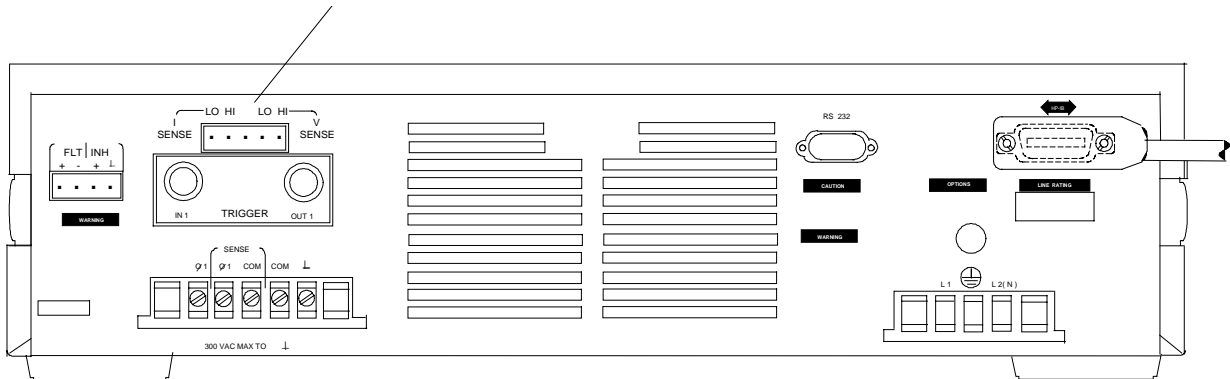

Rear Panel, Overall View

Installation

Turn the unit off before connecting any wires.

The Power Analyzer input to the ac source has both voltage and current sense inputs. Each sense input has a HI and a LO connection. The center pin of the connector is not used. The maximum isolation voltage to ground is 300 Vac (± 425 Vdc).

Use the 1-meter, HP supplied cable and connect the Power Analyzer input to the external shunt. Note that the cable connectors are keyed so that the cable will only fit one way. Disconnect the cable from the unit by pulling it straight back. Cable connections are shown in the following figure.

IMPORTANT: You should always connect the V SENSE inputs for the Power Analyzer input to operate properly, even if you are not making voltage measurements. This is because frequency measurements are made by sensing the voltage signal, and many of the power analyzer measurements depend on an accurate frequency measurement. If a voltage signal is not available, use SENSE:FREQUENCY:SOURCE (or its front panel equivalent) to select and measure the frequency from the current signal instead.

If the HP-supplied cable is too short, you may open the cable ends and replace the wiring in the cable with longer wires. Install the new cable in the same way as the original cable. The cable connectors accept wire sizes from AWG 22 to AWG 12. Firmly tighten the screws when making wire connections.

WARNING: *SAFETY HAZARD* You must replace the cable hoods after completing all connections. This is because the connector screw terminals will be at line potential during operation.

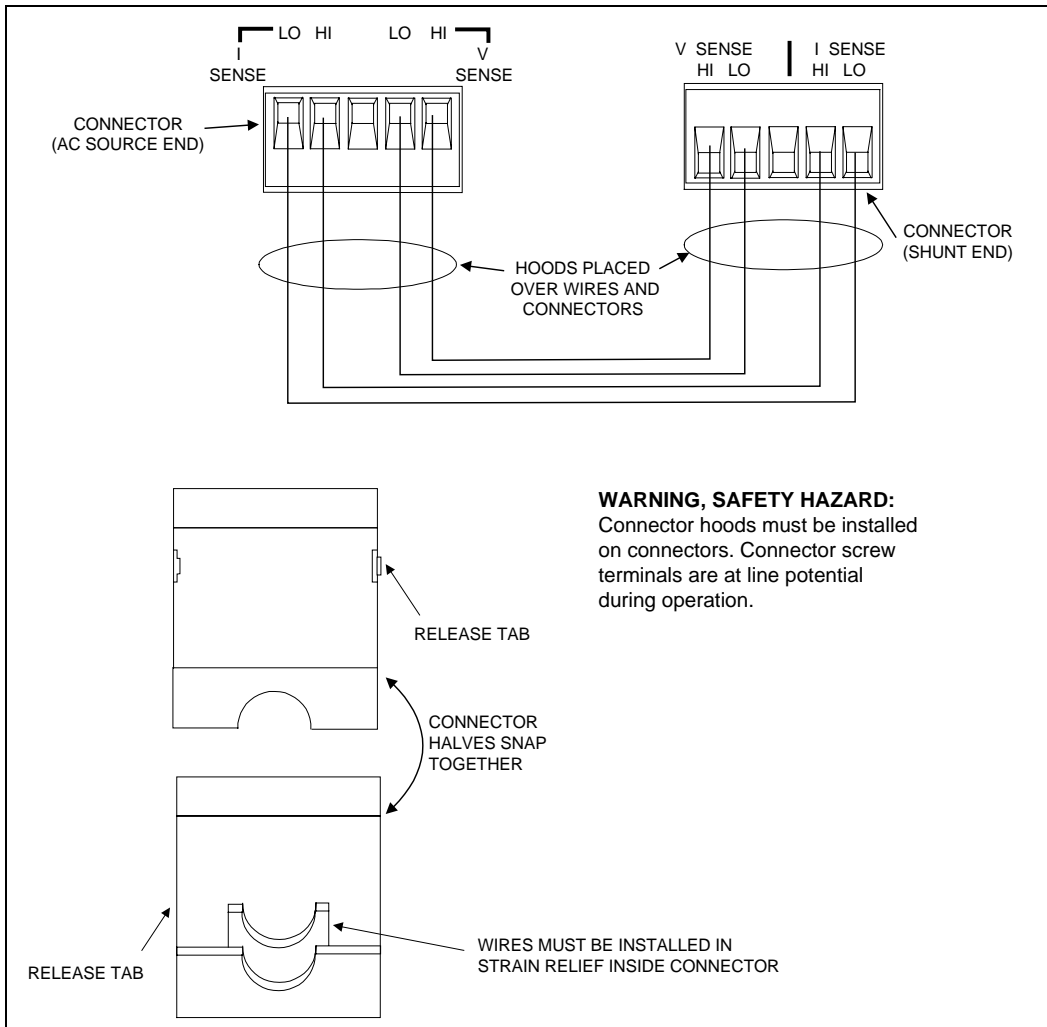

Measurement Cable Connections

Voltage Sensing at a Location Other than the External Current Shunt

You may also need to open up the cable connector if you need to voltage sense at a point other than at the external current shunt. You must use your own sense cable to make the voltage sense connections. Please completely remove the voltage sense wires from the HP-supplied measurement cable if you are using your own remote voltage sense cable. Disconnect the voltage sense wires from both cable connectors.

To use your own cable to voltage sense at a point other than the external current shunt, make the connections at the point where you will be remote sensing. Insert the other end of your cable into the HI and LO voltage sense terminals of the ac source connector. The cable connectors accepts wire sizes from AWG 22 to AWG 12. Firmly tighten the screws when making wire connections.

WARNING: *SAFETY HAZARD* You must replace the cable hoods after completing all connections. This is because the connector screw terminals will be at line potential during operation.

External Shunt Line and Load Connections

The HP-supplied current shunt has both input (line) and output (load) connectors. The customer must supply the cables to connect the ac lines to and from the external current shunt. HP supplies one hooded cable cover for the input of the ac source and two hooded cable covers for the shunt. All three of these covers are assembled and installed in the same way. It is the customer's responsibility to use these covers when making line cable connections. Note that a different cable cover is provided for the ac output of the ac source.

The following figure shows the Load and Line connectors on the external current shunt. Note the location of the line, neutral and ground connectors and connect your cables accordingly. Note that the connections on the output of the ac source are not in the same order on the barrier block as on the shunt barrier block.

WARNING: *SAFETY HAZARD* You must replace the cable hoods after completing all connections. This is because the screw terminals will be at line potential during operation.

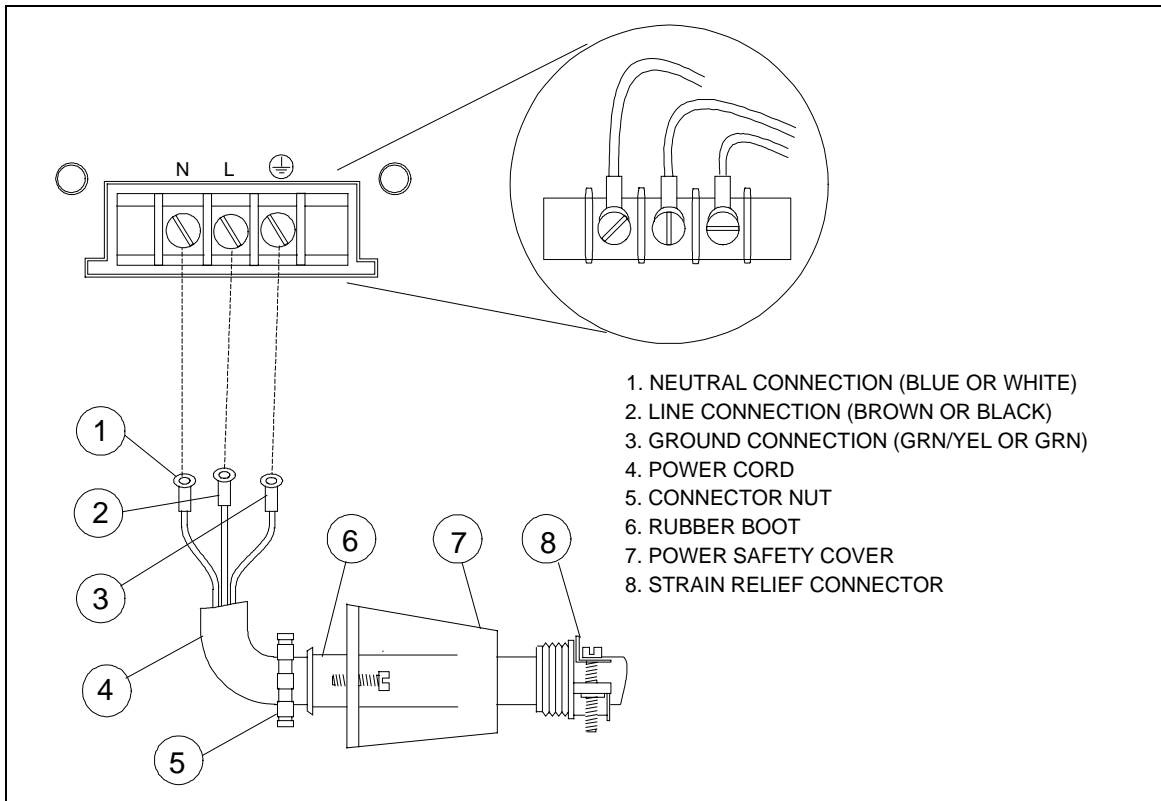

Line Connections

Check the External Current Shunt Setting

After you have completed your cable connections, you can turn on and check out the ac source as described in the Turn-On Checkout chapter in the ac source User's Guide. One additional step in checking out a unit with Option 020/022 installed, is to make sure that the correct shunt value has been entered in the unit. To check the shunt value setting, proceed as follows:

Action	Display
1. Turn on the ac source and wait for the unit to finish its internal selftest.	
2. Press Shift Calibration and scroll to the SHUNT command.	SHUNT 0.01
3. Check to see if the resistance value on the display matches the value written on the outside of the external current shunt. If it matches, press Meter to return to meter mode. You are done. If it does not match, you must enter the correct value. Proceed as follows:	
4. Press Shift Calibration , scroll to CAL ON and press Enter . If necessary, enter the calibration password from Entry keypad and press Enter . If the password is correct the Cal annunciator will come on.	CAL ON 0.0
5. Press Shift Calibration and scroll to the SHUNT command. Enter the shunt value written on the outside of the external current shunt exactly as it is written on the label. Then press Enter .	SHUNT 0.01
6. Press Shift Calibration , scroll to CAL SAVE, and press Enter .	CAL:SAVE
7. Press Shift Calibration , select CAL OFF, and press Enter to exit Calibration.	CAL OFF

NOTE: The shunt value that you enter applies only to the Power Analyzer input and has no effect on ac source output measurements. Therefore, ignore the $\phi 1$ and $\phi 2$ annunciators while entering the shunt value.

Front Panel Programming

Setting the Output Frequency Modulation

To set the output frequency modulation:

Action	Display
1. On the Function keypad, press Frequency . Then scroll to the FM:FREQ command to enter a modulating frequency. Use the numeric keypad to enter a modulating value and press Enter .	FM:FREQ 1
2. To set the peak frequency deviation of the output frequency modulation, press Frequency . Then scroll to the FM:DEV command to enter a frequency deviation. Use the numeric keypad to enter a value and press Enter . The deviation frequency must be less than the programmed output frequency by at least 0.001 Hz. Otherwise, it will result in Error 613.	FM:DEV 10
3. To enable frequency modulation, press Frequency , scroll to FM OFF , select the ON parameter and press Enter .	FM ON

Using the Front Panel Display with the Power Analyzer Input

To select the measurement source:

Action	Display
<p>Press Meter to return the display to Meter mode. Press Phase Select at any time to toggle between the Main Output and the Power Analyzer input. The left-most digit of the front panel display will indicate either "φ1" for the Main Output, or "φ2" for the Power Analyzer input. If the φ2 front panel display returns a very high frequency value, it usually means that there is no signal connected to the Power Analyzer input.</p> <p>Note that the Phase Select key also selects the measurement source to which the current range setting applies. The current range command is located in the Input menu.</p>	<p>φ² 115V 60Hz</p>

Making Power Analyzer Input Measurements

All measurements are based on acquiring and subsequently processing waveform information. Waveform information is acquired either from the ac source output or from the Power Analyzer input. When the ac source is on, it continually takes measurements and updates the front panel meter from whichever measurement source is active. The **Meter** key accesses the measurement functions from the front panel. This menu applies to both the ac source output and the Power Analyzer input.

NOTE: The **Shift Harmonic** functions also apply to the Power Analyzer input. If the display indicates OVL D, the measurement capability of the unit has been exceeded.

Use the Meter menu for making Power Analyzer input measurements:

Action	Display
1. Press Phase Select to toggle to the Power Analyzer input. A φ2 will appear on the display when the Power Analyzer input is selected.	φ ² 115V 3.04A
2. Press Meter and ▼ repeatedly to access the following measurement functions:	
◆ rms voltage and frequency (the default)	φ ² <reading>V <reading>Hz
◆ rms voltage and rms current	φ ² <reading>V <reading>A
◆ rms current and frequency (the default)	φ ² <reading>A <reading>Hz
◆ rms voltage and power	φ ² <reading>V <reading>W
◆ current crest factor	φ ² <reading> CREST F
◆ peak current, repetitive	φ ² <reading>A PK REP
◆ peak current, non-repetitive	φ ² <reading>A PK NR
◆ apparent power	φ ² <reading> VA
◆ reactive power	φ ² <reading> VAR
◆ power factor	φ ² <reading> PFACTOR

The ac source uses the output frequency value when calculating many of the output measurements. For ac source output measurements, the ac source uses the *programmed* output frequency value. For the Power Analyzer input, the ac source uses the frequency *measured* at the V SENSE input channel. This is the default setting. You can also select the I SENSE input channel as the frequency measurement source.

Use the Input menu for selecting the frequency source:

Action	Display
<p>If a voltage signal is not available to measure the output frequency, you must select the current measurement as the frequency source. Press Input, scroll to FREQ:SRC VOLT, select the CURR parameter and press Enter.</p>	<p>FREQ:SRC CURR</p>

Additional Measurement Commands

The following additional measurement commands are provided with the HP Dual Power Analyzer (Option 020/022). These measurement commands are optimized for use in specific applications such as evaluating uninterruptible power supplies. In this application the new commands can be used to measure transfer time, peak voltage, and phase locked loop performance of the UPS.

NOTE: All **MEASure** and **FETCh** commands apply to both the Main Output and the Power Analyzer input. This includes commands documented in the ac source User's Guide and those described in this section. See **SENS:NSEL** to select a power analyzer input.

MEASure:TVOLt? **FETCh:TVOLt?**

Returns the time at which the measured voltage crosses a user-specified voltage *level*. The sign and magnitude of *occurrence* define the event to be reported. For example, if *occurrence* is -3, the return value is the third time at which the voltage crosses the *level* in the negative-going direction. If *occurrence* is 4, the return value is the fourth time at which the voltage crosses the *level* in the positive-going direction.

The return value is with respect to the start of the measurement buffer. If no point on the waveform satisfies the specified conditions, the return value is 9.91000E+37.

Query Syntax MEASure:[SCALar]:TVOLt? <level>, <occurrence>
FETCh:[SCALar]:TVOLt? <level>, <occurrence>

Parameters -1E6 to 1E6 (for level)
-4096 to +4096, but not 0 (for occurrence)

Examples MEAS:TVOL? 50, 3 FETCh:TVOL? 10, -1

Returned Parameters <NR3>

Related Commands MEAS:TVOL:ABS?

MEASure:TVOLt:ABSolute? FETCh:TVOLt:ABSolute?

Returns the time at which the absolute value of the measured voltage first exceeds *level*, with the following qualifications: The behavior of the signal before *start_time* is ignored, and the absolute value of the voltage must remain above *level* for at least the specified *min_pulse_width*.

Both *start_time* and the return value are with respect to the start of the measurement buffer. If no point on the waveform satisfies the specified conditions, the return value is 9.91000E+37.

Query Syntax MEASure:[SCALar]:TVOLt:ABSolute? <level>, <start_time>,
<min_pulse_width>
FETCh:[SCALar]:TVOLt:ABSolute? <level>, <start_time>,
<min_pulse_width>

Parameters 0 to 1E6 (for level)
0 to 1E6 (for start time in seconds)
0 to 1E6 (for minimum pulse width in seconds)

Examples MEAS:TVOL:ABS? 50, 0, 0.001
FETC:TVOL:ABS? 100, 0.005, 0

Returned Parameters <NR3>

Related Commands MEAS:TVOL?

MEASure:VOLTage:RANKed? FETCh:VOLTage:RANKed?

Scans through the buffer of 4096 instantaneous voltage measurements, and returns the voltage value that corresponds to the *percentile* rank given. Specifying a percentile of 0 returns the lowest value in the buffer. A percentile of 100 returns the highest value in the buffer. A percentile of 50 returns the median value of the buffer. Stated another way, if you specify a percentile of 60, 60 percent of the voltage readings in the buffer are less than the returned value, and 40 percent of the readings in the buffer are greater than the returned value.

If the voltage waveform consists of rectangular pulses that have narrow overshoots, using percentiles of approximately 5 and 95 (depending on the width of the pulses and the width of the overshoots) is a good way to determine the voltages at the flat portions of the pulses.

Query Syntax MEASure:[SCALar]:VOLTage:RANKed? <percentile>
FETCh:[SCALar]:VOLTage:RANKed? <percentile>

Parameters 0 to 100

Examples MEAS:VOLT:RANK? 50

Returned Parameters <NR3>

Additional Sense Commands

The following additional sense commands are provided with the HP Dual Power Analyzer (Option 020/022). These commands let you select a measurement source and the frequency measurement channel for the Power Analyzer input.

SENSe:NSElect

Selects the measurement source that will return data when a query is sent. A parameter value of 1 selects the Main Output, which measures the actual output voltage and current of the ac source. A value of 2 selects the Power Analyzer input, which measures the voltage and current at the V SENSE and I SENSE input channels. Note that this command is similar to, but not the same as, the command **INSTRUMENT:NSElect** that is used in 3-phase sources.

Only the following commands are affected by the measurement source selection:

- Queries beginning with **MEASure** or **FETCh**
- **SENSe:CURRent:ACDC:RANGe** <range>

Command Syntax	SENSe:NSElect <NR1>
Parameters	1 2
*RST Value	1
Examples	SENS:NSEL 2
Query Syntax	SENSe:NSElect?
Returned Parameters	<NR1>

SENSe:FREQuency:SOURce

This command selects the frequency measurement source for the Power Analyzer input. It only applies when the Power Analyzer input is active.

Accurate frequency measurements are critical when making all Harmonic measurement calculations. Other measurement calculations also use frequency measurement values, but they only slightly affect the accuracy of the measurement. The ac source normally measures the frequency at the V SENSE input channel. With this comand you can select the I SENSE input channel as the frequency measurement source for the Power Analyzer input.

NOTE: For Main Output measurements, the ac source uses the *programmed* output frequency value when making measurement calculations.

Command Syntax	SENSe:FREQuency:SOURce <source>
Parameters	VOLTage CURRent
*RST Value	VOLTage
Examples	SENS:FREQ:SOUR CURR
Query Syntax	SENSe:FREQuency:SOURce?
Returned Parameters	<CRD>

Additional Frequency Modulation Commands

The following SCPI commands are used to program the output frequency of the ac source. These commands apply only to the Main Output of the ac source and do not affect the measurement capability of the unit. These commands are only provided with the HP Dual Power Analyzer (Option 020/022).

FM

Turns off or on frequency modulation of the Main Output. Frequency modulation operates only if FREQUENCY:MODE is set to FIXEd.

Command Syntax	[SOURCE:]FM[:STATe] <bool>
Parameters	0 1 OFF ON
*RST Value	OFF
Examples	FM 1 FM:STATE ON
Query Syntax	[SOURCE:]FM[:STATe]?
Returned Parameters	0 1
Related Commands	FM:DEV FM:FREQ

FM:DEVIation

Sets the peak frequency deviation of the output frequency modulation in Hertz. The frequency deviation must be **less** than the programmed output frequency by at least 0.001 Hz. For example, if the output frequency is set to 60 Hz, and you program a deviation of 10 Hz, the output frequency will modulate between 50 and 70 Hz at a rate determined by the FM:FREQUENCY command.

Command Syntax	[SOURCE:]FM:DEVIation <NRf>
Parameters	0 to 1000 Hz
*RST Value	0
Unit	Hz (Hertz)
Examples	FM:DEV 10
Query Syntax	[SOURCE:]FM:DEVIation?
Returned Parameters	<NR3>
Related Commands	FM FM:FREQ

FM:FREQUENCY

Sets the modulating frequency of the output frequency modulation in Hertz.

Command Syntax	[SOURCE:]FM:FREQUENCY <NRf>
Parameters	0.001 to 1000 Hz
*RST Value	0.1
Unit	Hz (Hertz)
Examples	FM:FREQ 1
Query Syntax	[SOURCE:]FM:FREQUENCY?
Returned Parameters	<NR3>
Related Commands	FM FM:DEV

Additional Calibration Commands

The following SCPI commands are used to calibrate the Power Analyzer input and external current shunt:

CALibrate:VOLTage:EXTernal

Initiates calibration of the external voltage measurement.

Command Syntax	CALibrate:VOLTage:EXTernal
Parameters	None
Examples	CAL:VOLT:EXT

CALibrate:CURREnt:EXTernal

Initiates calibration of the external current measurement.

Command Syntax	CALibrate:CURREnt:EXTernal
Parameters	None
Examples	CAL:CURR:EXT

CALibrate:SHUNt

Lets you enter the external current shunt value (in ohms). The external current shunt is used for external current measurement. The programming range is 1E-6 to 1E6. This parameter is nonvolatile, so there is no *RST value. As with other CAL commands, calibration must first be enabled with CAL:STATe, and the value must be made permanent with CAL:SAVE.

Command Syntax	CALibrate:SHUNt <value>
Parameters	Current shunt value in ohms
Examples	CAL:SHUN .01

Behavior Differences of Existing SCPI Commands

This section documents the behavior differences of existing SCPI commands when the Power Analyzer input is selected or is active.

MEASure | FETCh

All standard ac source MEASure or FETCh functions are available for the Main Output of the ac source as well as the Power Analyzer input. The SENSE:NSElect command selects the measurement source that will return data.

MEASure:FREQUENCY?

When the Power Analyzer input is selected as the measurement source, this command returns the actual frequency measured at the V SENSE input channel. When the Main Output of the ac source is selected as the measurement source, this command returns the programmed output frequency.

NOTE: With no signal connected to the Power Analyzer input, this command may return a very high frequency value. This is normal, since there is no external frequency for the measurement circuit to detect.

SENSe:CURRent:ACDC:RANGe <value>

Sets the current measurement range of the selected measurement source (see SENSE:NSElect). Normally when using the Main Output as the measurement source, you would put in a value and the ac source will automatically select the current range. If you are using the Power Analyzer input with an external current shunt as the measurement source, the crossover value of the current ranges can be determined with the following formula: $Crossover_value = 0.05713/shunt_resistance$. Values greater than the crossover value select the high current range. Alternatively, you can simply program MIN or MAX to select the low or high current range.

TRIGger:ACQuire and other measurement trigger commands

SENSe:SWEep:TINTerval and other measurement timebase commands

SENSe:WINDow

These commands always apply to both measurement sources, regardless of which source is selected.

*IDN?

Returns the same response as a standard ac source, except for the firmware revision number.

*OPT?

Returns 20, except that the HP 6813B 2000 VA model returns 22.

SYSTem:CONFigure <NORMal | IEC >

All Option 020 capabilities are only available in NORMal mode.

SYSTem:LANGuage <SCPI | E9012>

All Option 020 capabilities are only available in SCPI mode.

Programming Example

UPS Transfer Time Measurement

The following programming example illustrates how to use the ac source with the Dual Power Analyzer (Option 020 or 022) to measure transfer time on a UPS. Transfer time is defined as the time it takes a UPS to go from online-operation to battery-backup operation when the ac line fails.

This example starts with the ac source output voltage (UPS input voltage) at 120 Vac. The UPS output voltage is connected to a load and to the Power Analyzer input. The ac source output turns on at 120 Vac, then does a 50 ms dropout to 0 volts. Both the dropout and measurements are triggered at the same time. The FETC:TVOLT:ABS? command is then used to return the transfer time, here defined as the time between the start of the dropout and the time when the absolute value of the UPS output voltage exceeds 50 volts for at least 0.001 seconds.

```
100 ASSIGN @Ps TO 705      ! AC SOURCE IS AT ADDRESS 5, INTERFACE 700
110 !
120 !
130 OUTPUT @Ps;"*RST"      ! BEGIN FROM A KNOWN STARTING POINT WITH RESET
140 OUTPUT @Ps;"VOLT 120" ! SET INITIAL INPUT VOLTAGE FOR UPS TO 120 VAC
150 OUTPUT @Ps;"OUTP ON"  ! TURNS AC SOURCE OUTPUT ON AT 120 VAC
160 WAIT 2                 ! MAKE SURE UPS OUTPUT HAS TIME TO SETTLE
170 !
180 !
190 OUTPUT @Ps;"VOLT:MODE PULS" ! SET UP PULSE MODE FOR AC SOURCE OUTPUT
200 OUTPUT @Ps;"PULS:WIDT 0.05" ! SET PULSE WIDTH TO 50 MILLISECONDS
210 OUTPUT @Ps;"VOLT:TRIG 0"   ! SET PULSED (TRIGGERED) VALUE TO 0 VOLTS
220 !
230 !
240 OUTPUT @Ps;"TRIG:SYNC:SOUR PHAS" ! SETS DROPOUT SYNCHRONIZATION TO PHASE
250 OUTPUT @Ps;"TRIG:SYNC:PHAS 90" ! SETS DROPOUT START PHASE TO 90 DEGREES
260 OUTPUT @Ps;"TRIG:SOUR BUS"    ! SETS DROPOUT TRIGGER AND MEASUREMENT
270                               ! TRIGGER SOURCE TO BUS TRIGGER
280 !
290 !
300 OUTPUT @Ps;"OUTP:TTLT:SOUR BOT" ! SETS SIGNAL TRIGGER SOURCE TO BEGINNING
310                               ! OF TRANSIENT (BOT)
320 OUTPUT @Ps;"OUTP:TTLT:STAT ON" ! ENABLES TRIGGER OUTPUT SIGNAL
330 OUTPUT @Ps;"TRIG:ACQ:SOUR TTLT" ! SETS MEASUREMENT TRIGGER SOURCE TO
340                               ! TRIGGER OUTPUT SIGNAL
350 !
360 !
370 OUTPUT @Ps;"INIT:IMM:SEQ1" ! ARMS THE PULSED DROPOUT TO WAIT FOR TRIGGER
380 OUTPUT @Ps;"INIT:IMM:SEQ3" ! ARMS MEASUREMENT PROCESS TO WAIT FOR TRIGGER
390 OUTPUT @Ps;"TRIG:IMM"      ! TRIGGERS PULSED VOLTAGE DROPOUT TO 0 VOLTS
400                               ! AND STARTS THE MEASUREMENT PROCESS
410 OUTPUT @Ps;"SENS:NSEL 2"   ! SELECTS POWER ANALYZER INPUT FOR MEASUREMENTS
420 OUTPUT @Ps;"FETC:TVOLT:ABS? 50, 0, .001" ! FETCHES TRANSFER TIME
430 ENTER @Ps;A                ! RETURNS THE TRANSFER TIME MEASUREMENT
440 PRINT A                     ! PRINTS THE TRANSFER TIME MEASUREMENT
450 END
```

Using the Power Analyzer Input with the GUI

The HP AC Source Graphical User Interface (GUI) is an easy to use soft front panel for the HP 6800-series AC Power Source/Analyzers. It is supplied with your ac source. With it, you can also control the Power Analyzer input on the back of the unit.

Instructions to install and run the Graphical User Interface are provided in the Quick Start Guide that accompanies the software. Briefly:

1. Place Disk #1 in the A: drive of your computer and run SETUP.EXE.
2. Follow the directions on the screen to install the software.
3. To run the HP AC Source GUI, click on its desktop icon:
You can also click on the Start button and select:
Programs | HP AC Source | AC Source GUI.



The HP AC Source Graphical User Interface software recognizes if your ac source includes option 020 or 022, and automatically activates the controls for these options when the software is installed.

Making a Measurement

First, you must select the type of waveform to display and then make the measurement.

- Click on the **Config** button and then selecting the Config Waveform Display tab.
- Select the type of waveform to display from the Ext Power Analyzer dropdown box. Selections include voltage, current, voltage+current, or harmonic display functions.

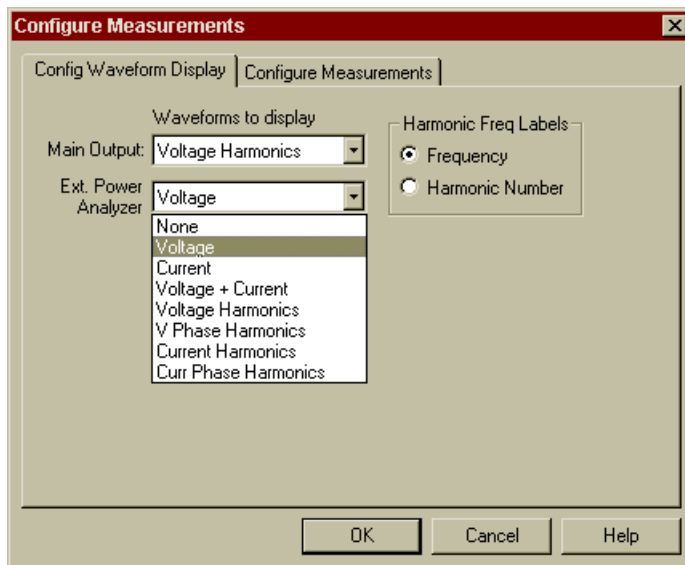

- For the Main Output, select from voltage, current, voltage+current, or harmonic display functions. If you only want one measurement window to appear, select **None** in the drop-down box of the measurement window that you do **not** want to appear.
- Click **OK** to return to the Main window.
- Click on the **Measure** button to make a single measurement.

If you have both the Main Output and the Power Analyzer input displayed, the Main window should display both waveforms, as illustrated in the following screen shot.

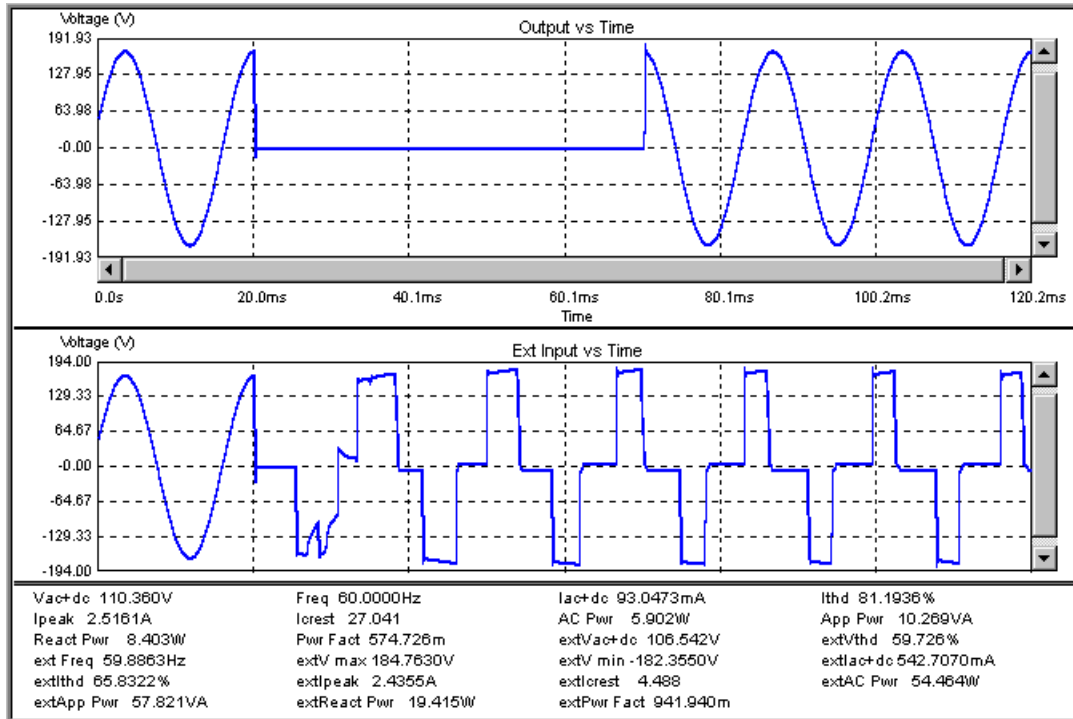

Making a Voltage Phase Difference Measurement

The voltage phase difference measures the phase difference between the output of the ac source and the output of a UPS after ac power is restored following an ac line dropout. This measurement requires that the output of the UPS be connected to the Power Analyzer input. Also, you must have already measured and displayed both the ac source output and the UPS output waveforms in the Main window.

To access the Voltage Phase Difference measurement, go to the **Tests** menu and select the **Voltage Phase Difference** command.

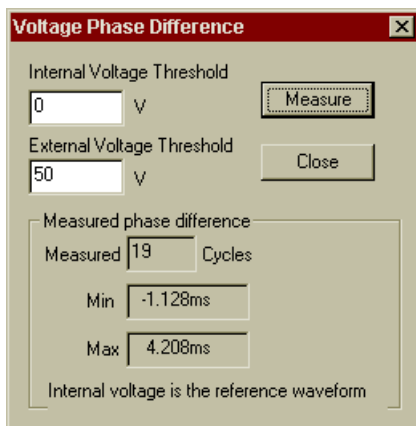

In the dialog box that appears on the screen, enter values for the indicated parameters. The test uses these parameters to make the measurement. For a detailed explanation of the Voltage Phase Difference parameters refer to the online help by pressing the F1 key.

When you are ready to make the measurement, press **Measure**.

Performing a Transfer Time Test

The transfer time test measures the time it takes the UPS to go from online-operation to battery backup operation when the ac line fails.

To access the Transfer Time Test, go to the **Tests** menu and select the **Transfer Time Test** command.

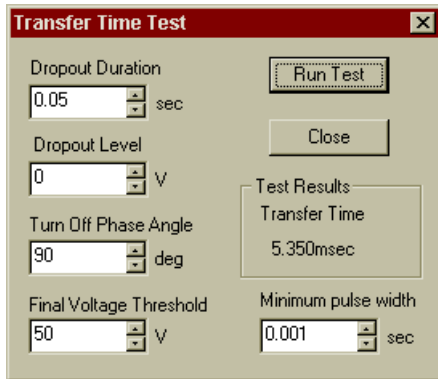

In the dialog box that appears on the screen, enter values for the indicated parameters. The test uses these parameters to run the test. For a detailed explanation of the Transfer Time test parameters refer to the online help by pressing the F1 key.

When you are ready to run the test, press Run Test.

Modulating the Output Frequency

AC sources equipped with option 020 or 022 have the capability to modulate the output frequency.

To access the Frequency Modulation dialog box, go to the **Source** menu and select the **Frequency Modulation** command.



In the dialog box that appears on the screen, enter values for the indicated parameters. For a detailed explanation of the Output Frequency parameters, refer to the online help by pressing the F1 key.

When you are finished, press Close. If FM has been enabled, the output frequency of the ac source starts modulating immediately.

Power Analyzer Input Specifications

Table A-1 lists the specifications of the HP Dual Power Analyzer Options 020 or 022. Performance specifications are warranted over the ambient temperature range of 0 to 40 °C. Unless otherwise noted, specifications are for a sinewave with a resistive load at a frequency range of 45 Hz to 1 kHz, with the HP-supplied current shunt, after a 30-minute warmup.

Table A-1. Performance Specifications

Measurement Accuracy (@25°C ±5°C), ± (% of output + offset)	rms Voltage (45–100 Hz): (>100–500 Hz): (>500 Hz–1 kHz): dc Voltage: rms Current High Range (45–100 Hz): (>100–500 Hz): (>500 Hz–1 kHz): rms Current Low Range (45–100 Hz): (>100–500 Hz): (>500 Hz–1 kHz): repetitive pk current High Range (45 Hz–1 kHz): repetitive pk current Low Range (45 Hz–1 kHz): Power (VA) Low Range (45–100 Hz): (>100–500 Hz): (>500 Hz–1 kHz): Power (VA) High Range (45–100 Hz): (>100–500 Hz): (>500 Hz–1 kHz): Power (Watts) Low Range (45–100 Hz): (>100–500 Hz): (>500 Hz–1 kHz): Power (Watts) High Range (45–100 Hz): (>100–500 Hz): (>500 Hz–1 kHz): Power Factor:	0.03% + 100 mV 0.1% + 100 mV 0.2% + 100 mV 0.03% + 150 mV 0.05% + 10 mA 0.05% + 15 mA 0.05% + 30 mA 0.05% + 1.5 mA 0.05% + 8 mA 0.05% + 25 mA 0.05% + 150 mA 0.03% + 150 mA 0.1% + 1.5 VA + 1.2 mVA/V 0.1% + 2 VA + 1.2 mVA/V 0.1% + 6 VA + 1.2 mVA/V 0.1% + 1.5 VA + 12 mVA/V 0.1% + 2 VA + 12 mVA/V 0.1% + 6 VA + 12 mVA/V 0.1% + 0.3 W + 1.2 mW/V 0.1% + 1.2 W + 1.2 mW/V 0.1% + 2.5 W + 1.2 mW/V 0.1% + 0.3 W + 12 mW/V 0.1% + 1.2 W + 12 mW/V 0.1% + 2.5 W + 12 mW/V 0.01
Harmonic Measurement Accuracy (50/60 Hz, @25°C ±5°C), ± (% of output + offset)	Voltage Magnitude: Current Magnitude (Low Range) Fundamental: Harmonics 2–49: Current Magnitude (High Range) Fundamental: Harmonics 2–49:	0.03% + 100 mV + 0.2%/kHz 0.03% + 1.5 mA 0.03% + 1 mA + 0.2%/kHz 0.05% + 5 mA 0.03% + 3 mA + 0.2%/kHz

Table A-2. Supplemental Characteristics

Isolation to Ground:		300 Vrms/425 Vdc
Measurement Ranges	AC Voltage: DC Voltage: Current:	0–300 Vrms ± 425 V ± 80 A peak (high range) ± 8 A peak (low range) 13 A rms max. continuous
Average Measurement Resolution	rms Voltage: rms Current:	10 mV 2 mA
THD (for a fundamental amplitude \geq 5% of full scale):		5% of reading + 0.1%
Measurement System Measurement Source Synchronization: Measurement Buffer Length: Measurement/Generation Synchronization: Measurement Acquisition Sampling Rate Range: Voltage/Current Digitization Accuracy: Voltage/Current Digitization Resolution: Harmonic Measurement Time (amplitude):	 Meas:Curr:Harm? <n> Meas:Array:Curr:Harm?	< 100 ns 4096 points \leq 50 μ s 25–250 μ s 12 bits 16 bts 400 ms 10 s

Verification and Calibration for Option 020/022

This section includes verification and calibration procedures for the HP Dual Power Analyzer Options 020 or 022. Add these procedures to those described in Appendix B of the AC Source User's Guide.

The verification procedures do not check all the operating parameters, but verify that the ac source is performing properly. Performance Tests, which check all the specifications of the ac source, are given in the applicable ac source Service Manual.

Because the output of the ac source must be enabled during verification or calibration, proceed with caution, since voltages and currents will be active at the output terminals.

Important Perform the verification procedures before calibrating your ac source. If the ac source passes the verification procedures, the unit is operating within its calibration limits and does not need to be re-calibrated.

WARNING *LETHAL VOLTAGES.* Ac sources can supply 424 V peak at their output. DEATH on contact may result if the output terminals or circuits connected to the output are touched when power is applied. These procedures must be performed by a qualified electronics technician or engineer trained on this equipment.

Equipment Required

The equipment listed in the following table, or the equivalent to this equipment, is required for verification and calibration.

Table B-1. Equipment Required

Equipment	Characteristics	Recommended Model
5-pin connector plug	This connector is supplied with the ac source when ordered with option 020 or 022.	HP p/n 0360-2681
Digital Voltmeter	Resolution: 10 nV @ 1 V Readout: 8.5 digits Accuracy: >20 ppm	HP 3458A
Current Monitor¹	0.01 Ω , ± 200 ppm,	Guildline 7320/0.01
Load Resistor	30 ohm, 100 Watts minimum	
Capacitor (calibration only)	1.0 μ F, 50 V	HP p/n 0160-3490
Function Generator (calibration only)	50 mV, 500 mV, 60 Hz sinewave capability	HP 33120A
HP-IB Controller	Full HP-IB capabilities	HP Series 200/300 or equivalent

¹The 4-terminal current shunt is used to eliminate output current measurement error caused by voltage drops in the load leads and connections. Connect the voltmeter directly to these current-monitoring terminals.

Verification Procedure

The following verification procedures assume you understand how to operate the ac source from the front panel as explained in chapter 4.

Perform the following tests for operation verification in the order indicated.

1. Turn-On Checkout
2. Voltage Measurement Accuracy
3. Current Measurement Accuracy

NOTE: The ac source must pass turn-on selftest before you can proceed with the verification.

Test Set up

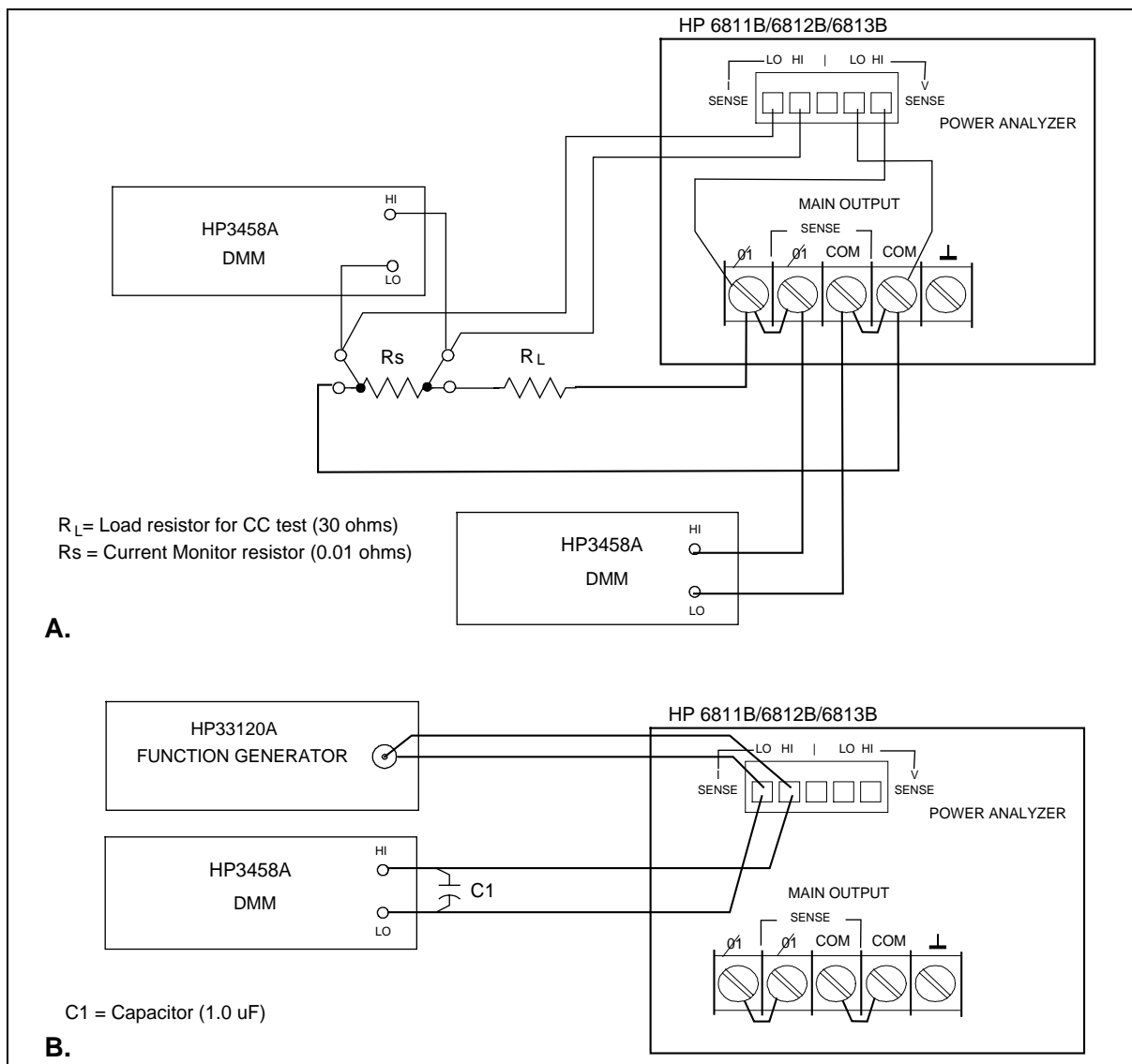

Figure B-1. Verification / Calibration Test Setup

Power Analyzer Voltage Measurement Accuracy

This test verifies the accuracy of the Power Analyzer voltage measurements. The Phase 2 annunciator on the left side of the display, must be on for the front panel to display Power Analyzer input measurements. Figure B-1A shows the setup. Measure the ac output voltage directly at the output terminals.

Action	Normal Result
1. Make sure the ac source is turned off. Connect the DVM to the output terminals the ac source. Connect the Power Analyzer voltage sense terminals (V SENSE) to the Main Output terminals of the ac source (see figure B-1A).	
2. Turn on the ac source with no load. In the Output menu, execute the *RST command to reset the unit to its factory default state.	*RST
3. If the Phase 2 annunciator does not appear on the right side of the display, press the Phase Select key.	ϕ^2 0 V 60 Hz
4. Program the output voltage to 150 volts and set the output current limit to its maximum value.	CV annunciator on.
5. Enable the output by pressing Output On/Off .	Output voltage near 150 V.
6. Record voltage readings at the DVM and on the front panel display.	ϕ^2 front panel reading within 145 mV of DVM reading .
7. Program the output voltage to 300 volts.	Output voltage near 300 V.
8. Record voltage readings at the DVM and on the front panel display.	ϕ^2 front panel reading within 190 mV of DVM reading

Power Analyzer Current Measurement Accuracy

This test verifies the accuracy of the Power Analyzer current measurements. The Phase 2 annunciator on the left side of the display, must be on for the front panel to display Power Analyzer input measurements. Figure B-1A shows the setup. Use the HP-supplied current shunt. It has the accuracy specified in table B-1. Use wire of sufficient size to carry the maximum rated current of the ac source.

NOTE: Check to make sure that the internal shunt value in the ac source matches the value written on the external current shunt. Refer to "Check the Shunt Value Setting".

Action	Normal Result
1. Turn off the ac source. Connect the 30 ohm load resistor, current shunt, and the DVM across the current shunt. Connect the Power Analyzer current terminals (I SENSE) to the output of the function generator (see figure B-1A).	
2. Turn on the ac source. In the Output menu, execute the *RST command to reset the unit to its factory default state.	*RST
3. If the Phase 2 annunciator does not appear on the right side of the display, press the Phase Select key.	ϕ^2 0 V 60 Hz
4. Program the output voltage to 100 volts and set the current limit to 3 amperes. Enable the output by pressing Output On/Off .	CC annunciator on. Output current near 3 amperes
5. Record the DVM voltage reading and calculate the rms current. Divide the DVM reading by the current monitor resistor value. Record the front panel reading.	ϕ^2 front panel reading within 11.5 mA of measured output current.

Calibration Procedure

Table B-1 lists the equipment required for calibration. Figure B-1 shows the test setup. The following procedures assume you understand how to operate front panel keys (see chapter 4).

WARNING *LETHAL VOLTAGES.* Ac sources can supply 425 V peak at their output. DEATH on contact may result if the output terminals or circuits connected to the output are touched when power is applied. These procedures must be performed by a qualified electronics technician or engineer trained on this equipment.

Summary of Front Panel Calibration Menu

The Entry keypad is used for calibration functions.

Shift Cal Press this key to access the calibration menu.

Display	Command Function
CAL ON <value>	Turns calibration mode on when the correct password value is entered.
CAL OFF	Turns calibration mode off
CAL:LEV <char>	Advance to next step in sequence (P1, P2, P3, or P4).
CAL:DATA <value>	Input a calibration measurement.
SHUNT <value>	Enter a value for the external current shunt in ohms.
CAL:VOLT:OFFSET	Begin voltage offset calibration
CAL:VOLT:DC	Begin dc voltage calibration sequence
CAL:VOLT:AC	Begin ac voltage calibration sequence
CAL:VOLT:PROT	Begin voltage protection calibration
CAL:VOLT:EXT	Begin external voltage calibration sequence
CAL:CURR:AC	Begin ac current calibration sequence
CAL:CURR:MEAS	Begin current measurement calibration sequence
CAL:CURR:EXT	Begin external current calibration sequence
CAL:IMP	Begin output impedance calibration sequence
CAL:SAVE	Saves the calibration constants in non-volatile memory.
CAL:PASS <value>	Set new calibration password.

Enable Calibration Mode

Action	Display
1. Reset the unit by selecting Shift, Output , and pressing Enter .	*RST
2. Press Shift Calibration , enter the calibration password from Entry keypad, and press Enter . If the password is correct, the Cal annunciator will come on. (If no password has been set, just press Enter .)	CAL ON 0.0
If the password is incorrect, an error occurs. If the active password is lost, the calibration function can be recovered by setting an internal switch that defeats password protection (see the Service Manual.)	OUT OF RANGE
If CAL DENIED appears, then an internal switch has been set to prevent the calibration from being changed (see the Service Manual.)	CAL DENIED

Calibrating and Entering Power Analyzer Voltage Calibration Values

Action	Display
4. Connect an HP 3458A DVM (in synchronous ac volts mode) to the ac source output terminals. Short the Power Analyzer voltage terminals (V SENSE) to ensure no dc offset error.	
5. Press Shift Calibration , scroll to CAL VOLT EXT, and press Enter .	CAL:VOLT:EXT
6. Leave the ac source on and remove the short from the Power Analyzer voltage terminals.	
7. Connect the Power Analyzer voltage sense terminals to the Main Output terminals of the ac source (see figure 3-1A).	
8. Press Shift Calibration , scroll to CAL LEV P1 and press Enter . The ac source will output 300 Vac 60 Hz sine wave.	CAL:LEV P1
9. Press Shift Calibration , scroll to CAL DATA, and use the Entry keypad to enter the voltage value displayed on the HP 3458A DVM.	CAL:DATA 0.00
10. Press Shift Calibration , scroll to CAL SAVE and press Enter .	CAL SAVE

Calibrating and Entering Power Analyzer Current Calibration Values

Action	Display
11. Short the Power Analyzer current sense terminals (I SENSE) to ensure no dc offset error.	
12. Press Shift Calibration , scroll to CAL CURR EXT and press Enter .	CAL:CURR:EXT
13. Leave the ac source on and remove the short from the Power Analyzer current terminals.	
14. Connect the Power Analyzer current terminals to the output of the function generator (see figure 3-1B). Set the function generator output to 50 mV, 60 Hz.	
15. Connect the Power Analyzer current terminals to the HP 3458A input terminals. Note that the HP 3458A must be in synchronous ac volts mode and a 1.0 uF capacitor must be installed across the HP 3458A input terminals.	
16. Press Shift Calibration , scroll to CAL LEV P1, and press Enter .	CAL LEV P1
17. Press Shift Calibration and scroll to CAL DATA. Use the Entry keypad to enter the voltage value displayed on the HP 3458A DVM.	CAL:DATA 0.00
18. Change the function generator output setting to 500 mV.	
19. Press Shift Calibration , scroll to CAL LEV P1 command, use ↓ to scroll to the P2 parameter, and press Enter .	CAL:LEV P2
20. Press Shift Calibration and scroll to the CAL DATA. Use the Entry keypad to enter the voltage value displayed on the HP 3458A DVM.	CAL:DATA 0.00
21. Press Shift Calibration , scroll to CAL SAVE and press Enter .	CAL SAVE